

User Manual of Xiaowa Robotic Vacuum Cleaner

Please read this user manual carefully before use and keep it well for future reference

XIaOWa

Safety Information

IMPORTANT SAFETY INSTRUCTIONS

When using an electrical appliance, basic precautions should always be followed, including the following:
READ ALL INSTRUCTIONS BEFORE USING (THIS APPLIANCE), Failure to follow the warnings and instructions may result in electric shock, fire and/or serious injury.

WARNING

To reduce the risk of fire, electric shock, or injury:

- Do not use outdoors or on wet surfaces
- Do not allow to be used as a toy. Close attention is necessary when used by or near children, pets or plants.
- Use only as described in this manual. Use only manufacturer's recommended attachments
- Do not use with damaged cord or plug. If appliance is not working as it should, has been dropped, damaged, left outdoors, or dropped into water, return it to a service center.
- Do not pull or carry by cord, use cord as a handle, close a door on cord, or pull cord around sharp edges or corners.
- Do not run appliance over cord. Keep cord away from heated surfaces.
- Do not unplug by pulling on cord. To unplug, grasp the plug, not the cord.
- Do not handle charger, including charger plug, and charger terminals with wet hands
- Do not put any object into openings. Do not use with any opening blocked; keep free of dust, lint, hair, and anything that may reduce air flow.
- Keep hair, loose clothing, fingers, and all parts of body away from openings and moving parts.
- Do not use to pick up flammable or combustible liquids, such as gasoline, or use in areas where they may be present.
- Do not pick up anything that is burning or smoking, such as cigarettes, matches, or hot ashes.
- Do not use without dust bag.
- Prevent unintentional starting. Ensure the switch is in the off-position before connecting to battery pack, picking up or carrying the appliance. Carrying the appliance with your finger on the switch or energizing appliance that have the switch on invites accidents.

Safety Information

- For use only with xiaowa CDZ03RR or CDZ04RR charger. Recharge only with the charger specified by the manufacturer. A charger that is suitable for one type of battery pack may create a risk of fire when used with another battery pack.
- Use appliances only with specifically designated battery packs. Use of any other battery packs may create a risk of injury and fire.
- Under abusive conditions, liquid may be ejected from the battery; avoid contact. If contact accidentally occurs, flush with water. If liquid contacts eyes, additionally seek medical help. Liquid ejected from the battery may cause irritation or burns.
- Do not use a battery pack or appliance that is damaged or modified. Damaged or modified batteries may exhibit unpredictable behavior resulting in fire, explosion or risk of injury.
- Do not expose a battery pack or appliance to fire or excessive temperature. Exposure to fire or temperature above 130° C may cause explosion.
- Follow all charging instructions and do not charge the battery pack or appliance outside of the temperature range specified in the instructions. Charging improperly or at temperatures outside of the specified range may damage the battery and increase the risk of fire.
- Have servicing performed by a qualified repair person using only identical replacement parts. This will ensure that the safety of the product is maintained.
- Do not modify or attempt to repair the appliance or the battery pack except as indicated in the instructions for use and care.
- Place the cords from other appliances out of the area to be cleaned.
- Do not operate the vacuum in a room where an infant or child is sleeping.
- Do not operate the vacuum in an area where there are lit candles or fragile objects on the floor to be cleaned.
- Do not operate the vacuum in a room that has lit candles on furniture that the vacuum may accidentally hit or bump into.
- Do not allow children to sit on the vacuum.

Safety Information

- Do not use the vacuum cleaner on a wet surface.
Risk Of Injury. Brush May Start Unexpectedly. Disconnect the main Brush Before Cleaning or Servicing.
- Do not use the product when the temperature is higher than 40°C or lower than 4°C, or there is any liquid or sticky substance on the floor

SAVE THESE INSTRUCTIONS

Household use only

IMPORTANTES MESURES DE S CURIT

L'utilisation d'un appareil électrique demande certaines précautions:

LIRE TOUTES LES INSTRUCTIONS AVANT DE FAIRE FONCTIONNER (CETAPPAREIL), Le non-respect des mises en garde et des instructions peut causer des chocs électriques, des incendies et/ou des blessures graves.

AVERTISSEMENT

- Pour réduire les risques d'incendie, de choc électrique ou de blessure:
- Ne pas exposer à la pluie, Ranger à l'intérieur.
- Ne pas permettre aux enfants de jouer avec l'appareil. Une attention particulière est nécessaire lorsque l'appareil est utilise par des enfants ou à proximité de ces derniers.
- N'utiliser que conformément à cette notice avec les accessoires recommandés par le fabricant.
- Ne pas utiliser si le cordon ou la fiche est endommagé. Retourner l'appareil à un atelier de reparation s'il ne fonctionne pas bien, s'il est tombé ou s'il a été endommagé, oublié à l'extérieur ou immergé.
- Ne pas tirer soulever ni trainer l'appareil par le cordon. Ne pas utiliser le cordon comme une poignée, le coincer dans l'embrasure d'une porte ou l'appuyer contre des arêtes vives ou des coins. Ne pas faire rouler l'appareil sur le cordon. Garder le cordon à l'écart des surfaces chaudes.
Ne pas débrancher en tyrant sur le cordon. Tirer plutt la fiche.

Safety Information

- Ne pas manipuler le chargeur, y compris la prise du chargeur, et les bornes du chargeur avec les mains mouillées
- N'insérer aucun objet dans les ouvertures. Ne pas utiliser l'appareil lorsqu'une ouverture est bloquée. S'assurer que de la poussière, de la peluche, des cheveux ou d'autres matières ne réduisent pas le débit d'air. Maintenir les cheveux, les vêtements amples, les doigts et toutes les parties du corps à l'écart des ouvertures et des pièces mobiles.
- User de prudence lors du nettoyage des escaliers.
- Ne pas aspirer des liquides inflammables ou combustibles, comme de l'essence, et ne pas faire fonctionner dans des endroits où peuvent se trouver de tels liquides.
- Ne pas aspirer de matières en combustion ou qui dégagent de la fumée, comme des cigarettes, des allumettes ou des cendres chaudes.
- Ne pas utiliser l'appareil si le sac à poussière ou le filtre n'est pas en place.
- Éviter une mise en marche accidentelle. S'assurer que l'interrupteur est à la position arrêt avant de raccorder la batterie, de lever ou de déplacer l'appareil.
Transporter l'appareil en gardant un doigt sur l'interrupteur, ou mettre sous tension un appareil dont l'interrupteur est à la position marche peut causer un accident.
- Pour emploi seulement avec xiaowa CDZ03RR ou CDZ04RR chargeur. Recharger uniquement avec le chargeur prescrit par le fabricant. Un chargeur convenant à un type de batterie peut présenter un risque d'incendie lorsqu'il est utilisé avec une autre batterie.
- Utiliser uniquement les batteries recommandées pour l'appareil. L'utilisation d'autres types de batteries peut présenter un risque de blessure ou d'incendie.
- Lorsque l'appareil n'est pas utilisé, tenir la batterie loin d'objets métalliques comme des trombones, des pièces de monnaie, des clés, des clous, des vis ou autres petits objets qui pourraient établir une liaison entre les bornes. Un court-circuit des bornes des batteries peut causer des brûlures ou un incendie.
- En condition d'usage abusif, du liquide peut s'échapper de la batterie ; éviter tout contact avec ce liquide. En cas de contact accidentel, rincer abondamment avec de l'eau. En cas de contact avec les yeux, consulter également un médecin. Le liquide projeté peut causer des irritations ou des brûlures.

Safety Information

- Ne pas utiliser une batterie ou un appareil endommagé ou qui a été modifié. Des batteries endommagées ou modifiées peuvent avoir un comportement imprévisible pouvant causer un incendie, une explosion ou un risque de blessure.
- Ne pas exposer une batterie ou un appareil à la flamme ou à des températures excessives. L'exposition à une flamme ou à des températures supérieures à 130 °C peut causer une explosion.
- Respecter toutes les instructions de chargement et ne pas charger la batterie ou l'appareil à des températures qui ne sont pas incluses dans la gamme de températures indiquées dans la notice d'instructions. Un chargement mal effectué.
- Confier les réparations à une personne qualifiée qui utilisera uniquement des pièces de remplacement identiques. Cette façon de faire garantira la sécurité du produit.
- Ne pas modifier ni tenter de réparer l'appareil ou la batterie sauf comme il est indiqué dans les instructions d'utilisation et d'entretien.
- Éloigner les cordons d'autres appareils de la zone à nettoyer.
- Ne pas utiliser l'aspirateur dans une pièce où un nourrisson ou un enfant dort.
- Ne pas utiliser l'aspirateur dans un endroit où il ya des bougies allumées ou des objets fragiles sur le plancher à nettoyer.
- Ne pas utiliser l'aspirateur dans une pièce où il ya des bougies allumées sur les meubles que l'aspirateur peut heurter ou se cogner accidentellement.
- Ne pas laisser les enfants s'asseoir sur l'aspirateur.
- Ne pas utiliser l'aspirateur sur une surface mouillée.
Risque de blessures. La brosse motorisée peut se mettre en marche d'une manière imprévue.
- Déconnecter la brosse principale avant le nettoyage ou le service.

CONSERVER CES INSTRUCTIONS

Usage Domestique seulement

Laser Safety

Class I Laser Product, complies with FDA 21 CFR 1040.10 and 1040.11, except for deviations pursuant to Laser Notice. No.50, dated June 24, 2007.

FCC Statement

Compliance Information	
Product Name	Robotic Vacuum Cleaner with Dock Charger
Produce Model	Robotic Vacuum Cleaner Model: E2*****, E3***** (*can be 0 to 9, A to Z, a to z, "-", "_", "\", "/" or blank, for marketing purpose.) Dock Charger Model: CDZ03RR , CDZ04RR
Compliance Statement	This device complies with part 15 of the FCC Rules. Operation is subject to the following two conditions: (1) This device may not cause harmful interference, and (2) this device must accept any interference received, including interference that may cause undesired operation
Correspondence of the responsible party in USA	
Company	Roborock Technology Co.
Address	108 West 13th Street, Wilmington, Delaware 19801.
Email	support@roborock.com

Warning:

Any changes or modifications to this unit not expressly approved by the party responsible for compliance could void the user's authority to operate the equipment.

Le présent appareil est conforme aux CNR d'Industrie Canada applicables aux appareils radio exempts de licence. L'exploitation est autorisée aux deux conditions suivantes :

- (1) l'appareil ne doit pas produire de brouillage, et
- (2) l'utilisateur de l'appareil doit accepter tout brouillage radio électrique subi, même si le brouillage est susceptible d'en compromettre le fonctionnement.

FCC Statement

Changes or modifications not expressly approved by the party responsible for compliance could void the user's authority to operate the equipment.

This equipment has been tested and found to comply with the limits for a Class B digital device, pursuant to part 15 of the FCC Rules. These limits are designed to provide reasonable protection against harmful interference in a residential installation. This equipment generates uses and can radiate radio frequency energy and, if not installed and used in accordance with the instructions, may cause harmful interference to radio communications. However, there is no guarantee that interference will not occur in a particular installation. If this equipment does cause harmful interference to radio or television reception, which can be determined by turning the equipment off and on, the user is encouraged to try to correct the interference by one or more of the following measures:

- Reorient or relocate the receiving antenna.
- Increase the separation between the equipment and receiver.
- Connect the equipment into an outlet on a circuit different from that to which the receiver is connected.
- Consult the dealer or an experienced radio/TV technician for help.

MPE Requirements

To satisfy FCC / IC RF exposure requirements, a separation distance of 20 cm or more should be maintained between the antenna of this device and persons during device operation.

To ensure compliance, operations at closer than this distance is not recommended.

L'antenne installée doit être située de façon à ce que la population ne puisse être exposée à une distance de moins de 20 cm. Installer l'antenne de façon à ce que le personnel ne puisse approcher à 20 cm ou moins de la position centrale de l'antenne. La FCC des États-Unis stipule que cet appareil doit être en tout temps éloigné d'au moins 20 cm des personnes pendant son fonctionnement.

CAN ICES-3 (B)/NMB-3(B)

Battery and Charging

- Please keep the dock charger away from heat (such as heating plates)
- The battery must be removed from the appliance before it is scrapped
- The appliance must be disconnected from the supply mains when removing the battery
- The battery is to be disposed of safely. Please do not discard waste batteries. Leave them to a professional recycling organization
- Do not wipe or clean the chargers shrapnel with a piece of wet cloth or wet hands
- Please make sure the cleaner is powered off in shipment and original packaging is advised
- If left unused for a long period, please store the cleaner in a cool and dry place after having it fully charged and switched off, charge it at least every three months to avoid the battery being over discharged
- Please do not use the product when the temperature is higher than 40°C or lower than 4°C, or there is any liquid or sticky substance on the floor

Battery pack charging temperature		4°C~40°C	@Max Charging Current:0.5C
Battery pack using temperature		4°C~40°C	@Max Discharge Current:0.5C
Battery pack storage temperature	Storage(1month)	-20°C~60°C @Less than 70% RH	If the battery pack store at 25°C over the 3 months period, it should be recharged.
	Long Storage(3months)	-20°C~45°C @Less than 70% RH	
	Long Storage(1year)	-20°C~20°C @Less than 70% RH	

Introduction

Machine

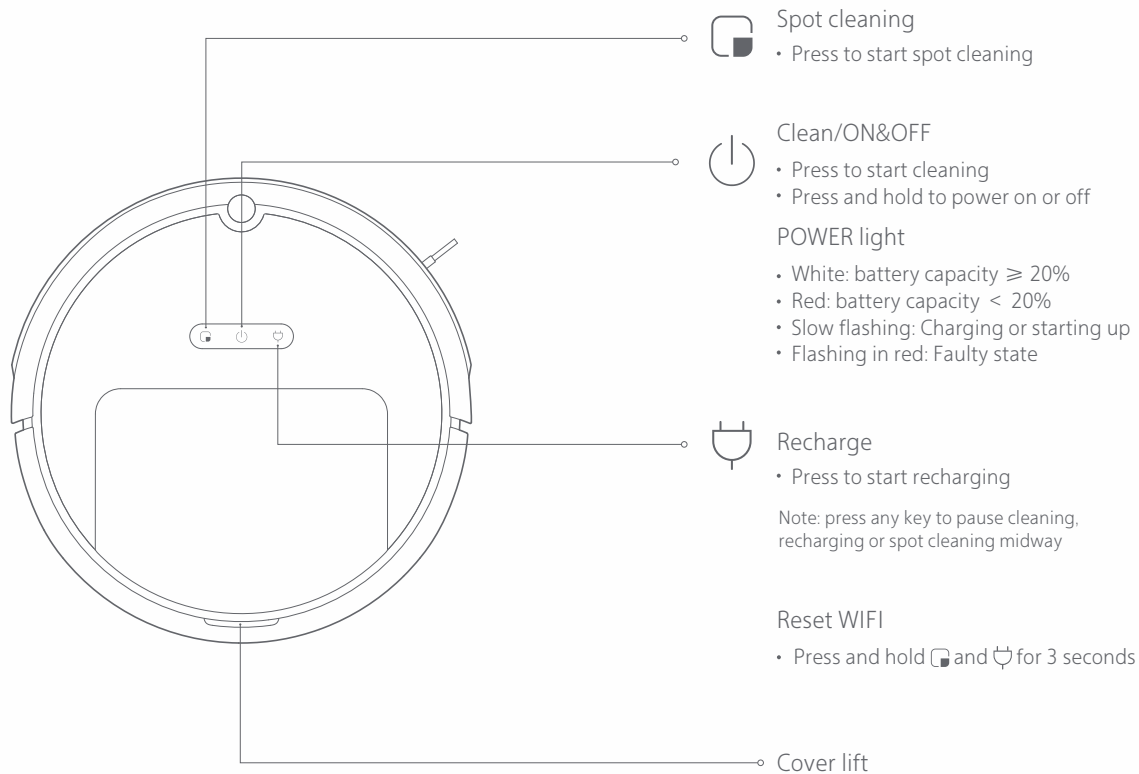

Introduction

Part list



Water tank



Mopping cloth

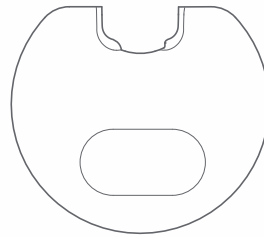

Moistureproof mat

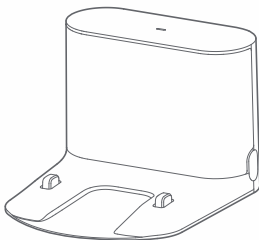

Dock charger



Main brush cleaning tool

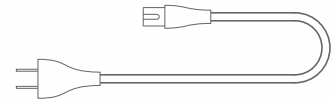

Power cable

Introduction

Dust bin

Machine

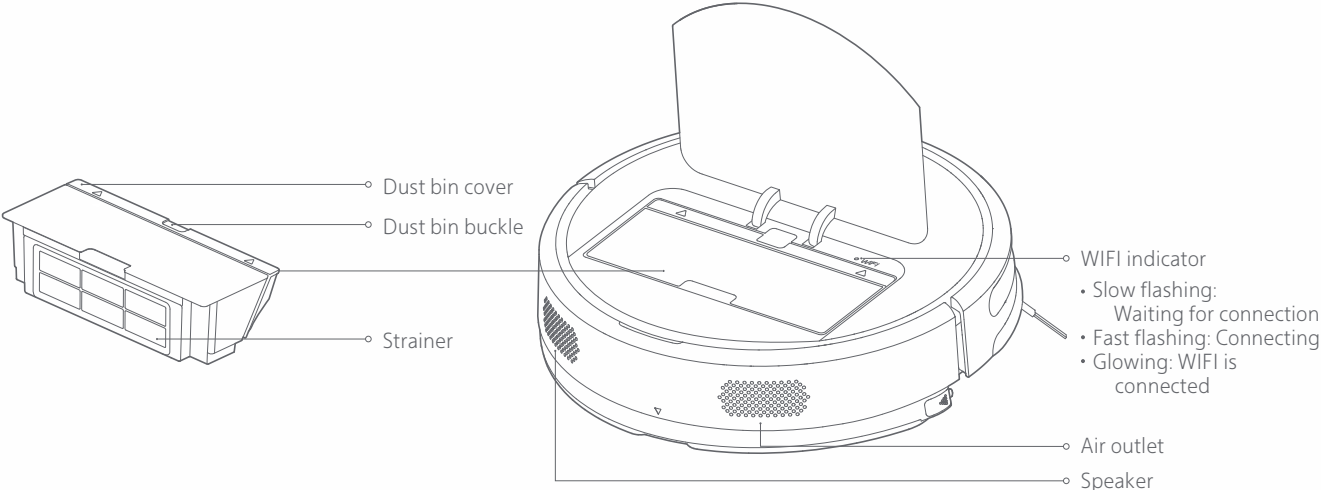

Introduction

Machine and sensor

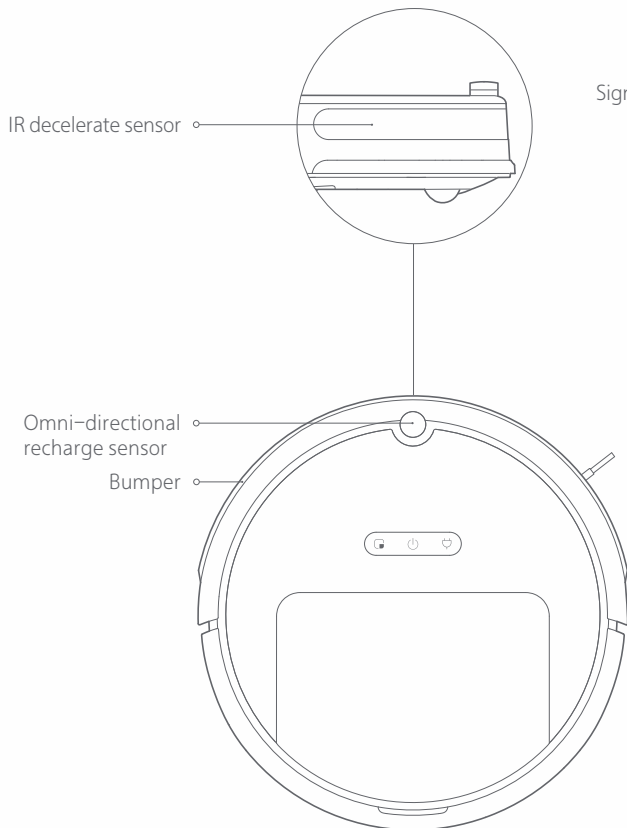

Dock charger

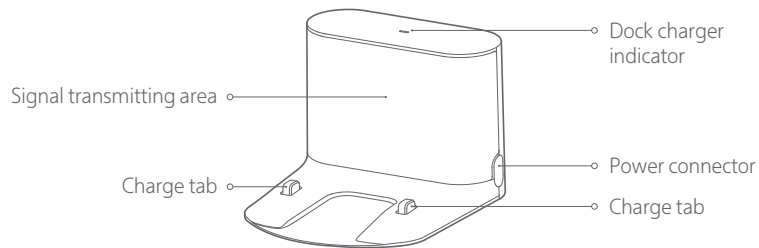

Cliff Sensor

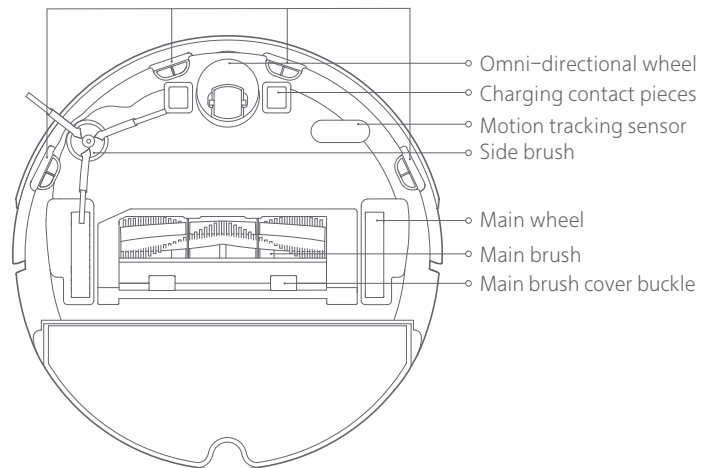

Installation

- 1 Clip the dock charger into the groove of the waterproof mat and install it in place

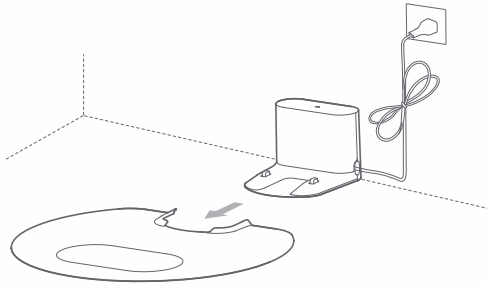

- 2 Place the dock charger against a wall on a level floor and connect it to the power supply

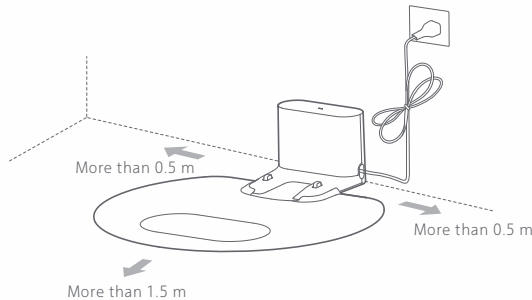

Notes:

- Ensure that 0.5 m or above in two sides and 1.5 m in the front are retained for the dock charger
- The power cable, when being vertical to the floor, may be dragged by the machine body, thereby resulting in displacement or disconnection of the dock charger
- The dock charger indicator is normally on when the dock charger is electrified, and off when the dock charger works

- 3 Power on and charge

Press and hold the  key to power on, wait until the power light is normally on, and then dock the machine body to the dock charger for charging

The machine is equipped with a built-in high performance lithium-ion rechargeable battery pack. To maintain battery performance, please keep the machine charged for normal use.

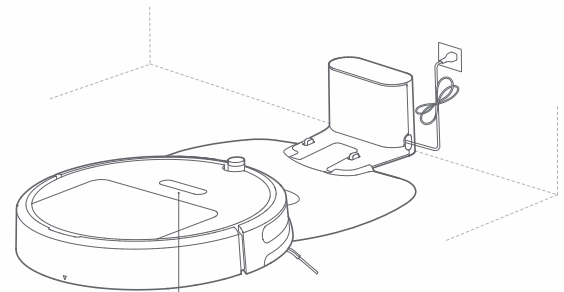

The color of the POWER light indicates the battery level

- White: battery capacity \geq 20%
- Red: battery capacity $<$ 20%

Note: The machine may not be powered on when the battery is low. Please directly dock the machine body to the dock charger

- 4 Connect your mobile phone client (this can be skipped)

Installation

The product is compatible with Mi Home intelligent platform and could be controlled by Mi Home app. It supports the MIUI system and can be interconnected with other Mi Home intelligent products

Quick Setup

① Download App

Search "Mi Home" in App store/Google play or scan the QR code below to download and install the Mi Home app.





② Add Device

Go to "My Device" page of Mi Home app and tap "+" on the top right corner of the page to add a device. You could find newly added device on "My Device" list

③ Reset WIFI

If anything is wrong with WIFI connection, you could try to reset WIFI to default.

Open upper cover to check the WIFI indicator status next to reset button. Press and hold the  key and  key until you hear the voice "Reset WIFI ". The resetting is completed when the WIFI indicator starts to flash slowly and the cleaner will enter a pending connection state.

Installation

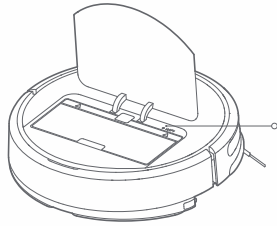

WiFi indicator

- Slow flashing: Waiting for connection
- Fast flashing: Connecting
- Glowing: WiFi is connected

Note: When your mobile phone fails to connect to the machine, please refer to "User Manual" – "Reset WiFi"

5 Install the mopping module

- ① Refill the water tank: open the water tank and reinstall the water tank cover after refilling with tap water

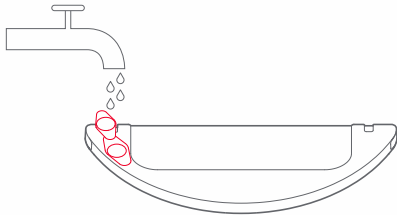

Note: Please be aware that some floor cleaners or disinfectants may cause blockage of the water tank filter

- ② Install the mopping cloth: dampen the mopping cloth and squeeze it dry. Insert it to the end along the slot of the water tank and stick it firmly

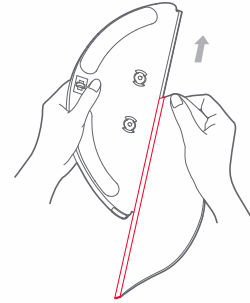

Note: Do not use the mopping module when there is nobody at home

- ③ Install the module: push the module in parallel along the alignment signs on the rear of the machine and on the mopping module. It is installed in place when you hear a "click" sound.

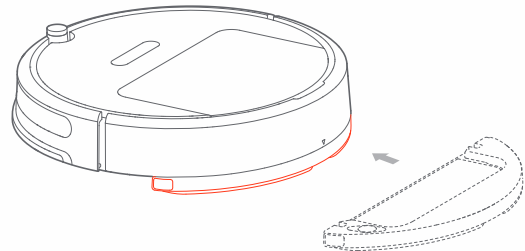

Note: To get better mopping effect, it is recommended to install the mopping module after cleaning for 3 times

Installation

6 Start cleaning

When the power light changes from white breathing flash to normally on, charging completes. Press the  key or use your mobile phone client to start cleaning

Note:

- Do not use the mopping module when there is nobody at home
- It is recommended to clean the mopping cloth every 30 minutes to ensure water flow rate and cleaning effect

7 Remove the mopping module

After the machine completes cleaning and returns to the dock charger, use your hands to push two buckles in two sides, drag the mopping module backwards and remove it

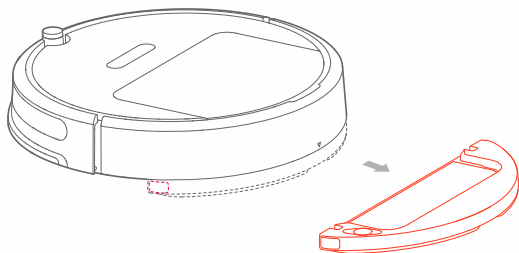

Note:

- Remove the mopping module when the machine is charging or left unused. Empty water residue in the water tank and clean the mopping cloth to prevent mildew or undesirable odor
- When the dock charger is placed on a wooden floor, always place a moisture-proof mat thereunder to avoid moisture on the floor

Routine Maintenance

Main brush * Clean weekly

1. Flip the machine over and push the buckle to remove the main brush cover
2. Lift the main brush up and clean its bearing
3. Use the supplied main brush cleaning tool to cut off hair entangled onto the main brush
4. Reinstall the main brush and clamp tightly the buckle on the main brush cover

Note: It is recommended to replace the main brush every 6-12 months to ensure the cleaning effect

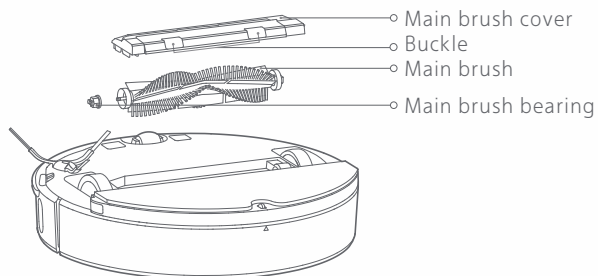

Use of main brush cleaning tool

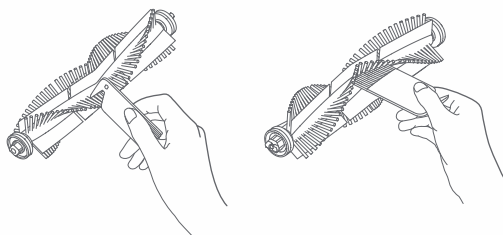

Routine Maintenance

Dust bin and strainer *Clean weekly

1. Remove the top cover of the machine and press the dust bin buckle to lift up and remove the dust bin

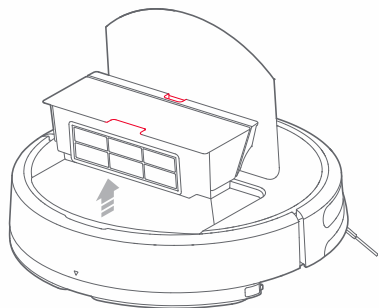

2. Open the dust bin cover as indicated by arrow, and empty trash out

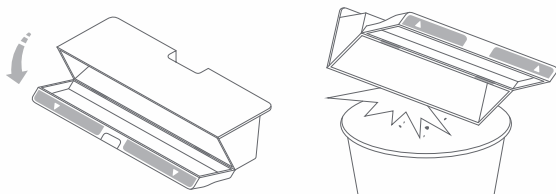

Clean the washable strainer *Clean every two weeks

1. Open the dust bin cover as indicated by arrow

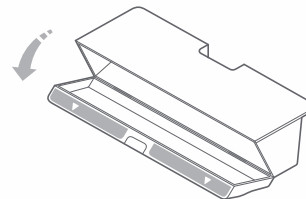

2. Fill the dust bin with clean water and close the cover. Shake the dust bin and then pour out the dirty water

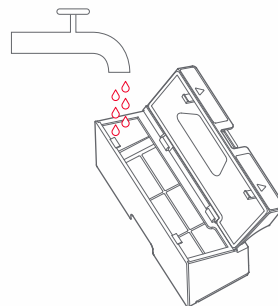

Note: Please rinse with clean water without adding any detergents

Routine Maintenance

3. Remove the filter and rinse with water

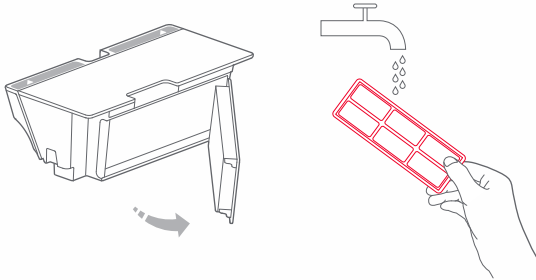

Note: Do not touch the surface of the filter with hands, brushes or sharp objects so as to avoid damaging the filter

4. Rinse repeatedly and lightly pat the filter to remove any dirt. Continue until it is clean



5. Dry the filter thoroughly and reinstall it before use

Note:

- Always dry the filter thoroughly before use (dry for at least 24 hours)
- It is recommended to alternate between two strainers

Side brush *Clean monthly

1. Flip the machine over to remove the fixing screw on the side brush
2. Remove and clean the side brush
3. Reinstall the side brush and tighten the screw

Note: It is recommended to replace the side brush every 3-6 months to ensure the cleaning effect

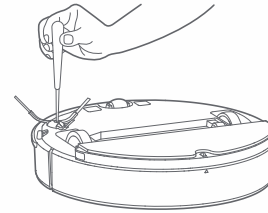

Omni-directional wheel *Clean monthly

1. Flip the machine over and lift the omni-directional wheel up
2. Remove hair and dirt on the wheel body and axle
3. Reinstall the wheel body and press tightly

Note: flush it with tap water and reinstall after drying

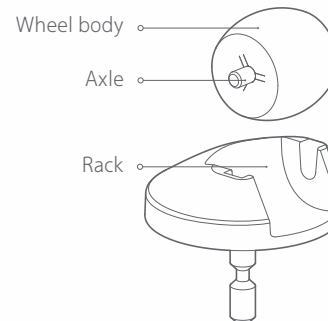

Routine Maintenance

Mopping cloth *Clean after use

1. Remove the mopping cloth from the mopping module

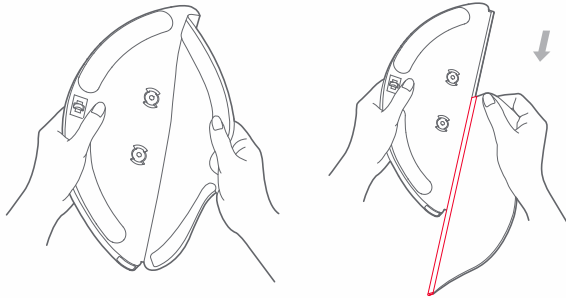

2. Clean the mopping cloth and dry it

Note:

- Always remove the mopping cloth for cleaning and avoid backflow of dirty water that may block the filter
- If the mopping cloth is too dirty, the mopping effect may be affected. Please clean it before use
- It is recommended to replace the mopping cloth every 3–6 months to ensure the cleaning effect

Filter assembly *Replace every 1–3 months

1. Use your finger to remove the filter assemblies on the left and right along the notch
2. Install a new filter assembly in place

Note: It is recommended to replace a filter assembly every 1–3 months to ensure the cleaning effect, depending on the quality of water and frequency of use.

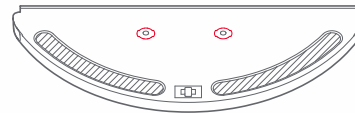

Battery

The machine is internally provided with a high performance lithium-ion rechargeable battery pack. To maintain battery performance, please keep the machine charged in normal use

Note: If the machine is left unused for a prolonged period of time, please power it off before storage and charge it at least every 3 months to avoid degradation due to over-discharge

Routine Maintenance

Machine sensor *Clean monthly

Use soft dry cloth to wipe and clean each sensor, including:

1. Four cliff sensors on the bottom of the machine
2. IR decelerate sensor in front of the machine
3. Charging contact on the bottom of the machine

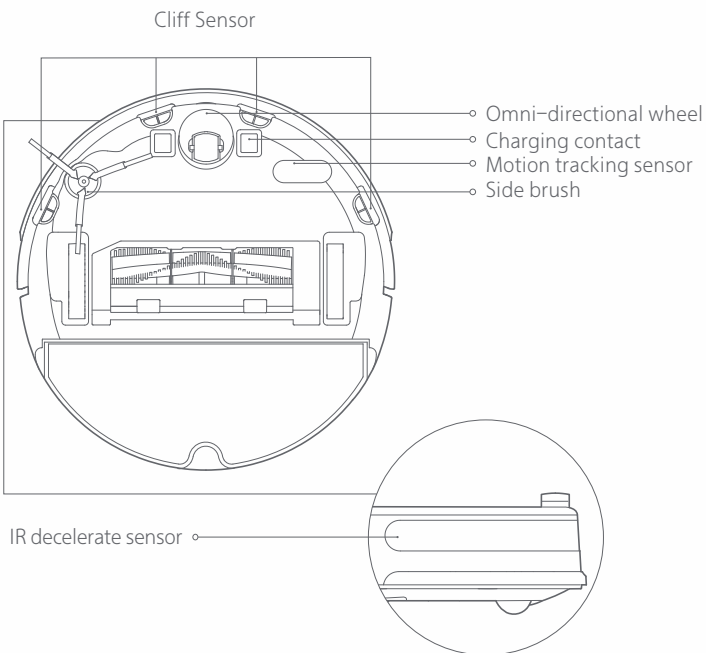

Dock charger *Clean monthly

Use soft dry cloth to clean the charging contact of the dock charger



Firmware update

You can use your mobile phone client to update firmware for the machine. Please connect it to the dock charger and ensure that the battery capacity is more than 20% before update. The power indicator is fast flashing in white during firmware update

Reset system

When pressing keys makes no response or the machine cannot be shut down, please try to reset the system by pressing the  key; the machine will be restarted automatically after resetting

Restoring to Factory Defaults

If the system still doesn't work after resetting, please press and hold the    button simultaneously, until the system prompts for "Start restoring initial version". The machine will be restored to factory defaults in this way

Basic parameters

Machine

Name	Specs	Specs
Model	E2*****, (*can be 0 to 9, A to Z, a to z, "-", "_", "\", "/" or blank,for marketing purpose.)	E3*****, (*can be 0 to 9, A to Z, a to z, "-", "_", "\", "/" or blank,for marketing purpose.)
Outline Dimension	353x350x90.5mm	353x350x90.5mm
Battery	14.4V/2600mAh lithium battery	14.4V/5200mAh lithium battery
Weight	About 3.0kg	About 3.2kg
Wireless connection	WIFI Smart Connect	WIFI Smart Connect
Voltage rating	14.4VDC	14.4VDC
Power rating	54W	58W

Dock charger

Name	Specs
Model	CDZ03RR or CDZ04RR
Outline Dimension	151x130x98mm
Power rating	42W
Input rating	100-240VAC
Output rating	20VDC 1.8A
Frequency rating	50-60Hz

Xiaowa Model Comparison

	Xiaowa Lite	Xiaowa	Xiaowa Plus
Model (*can be 0 to 9, A to Z, to z, "-" , "_" , "/" or blank, for marketing purpose.)	Xiaowa C1 *****	Xiaowa E2 *****	Xiaowa E3 *****
Cleaning method			
Wet mopping function	No mopping	Sweeping + mopping	Sweeping + mopping
Navigation method	Adaptive random navigation	Inertial navigation route planning	Inertial navigation route planning
Automatic recharge	√	√	√
Cleaning capacity			
Obstacle clearance height	2.0cm	2.0cm	2.0cm
Max suction	1600Pa	1800Pa	2000Pa
Dust bin capacity	640 ml	640 ml	640 ml
Max run time	60 minutes	90 minutes	150 minutes
Battery capacity	2600mAh	2600mAh	5200mAh
Extended app functions			
Cleaning map	No map	Pixel map	Pixel map
Timer cleaning	√	√	√
Smart home interconnection	√	√	√
Carpet Boost	√	√	√
Hardware system			
Fall prevention	√	√	√
Washable strainer		√	√
Moistureproof mat		√	√

Troubleshooting

No.	Problem Type	Solution
1	Unable to power on	The battery level is low. Please put the machine back onto the dock charger to charge it before use. Ambient temperature is too low or too high . Please use the machine in 4-40°C.
2	Unable to charge	The dock charger is not plugged in. Please confirm the two ends of the power cable are properly plugged. Contact is poor. Please clean the contact tab on the dock charger and the charging contact on the machine. Please confirm whether the charging indicator is on.
3	Unable to recharge	There are too many obstacles near the dock charger. Please place it in an open area. The machine is too far from the dock charger. Please put it near the dock charger.
4	Slow charging speed	1. When used at high or low temperatures, the machine will automatically reduce the charging speed so as to extend battery life. 2. The charging contact areas may be dirty. Please use a dry cloth to clean such areas.
5	Too short cleaning time or too long recharging time	Place the dock charger on an open area (living room, for example), rather than a confined space or a place where excessive obstacles exist.
6	Abnormal behavior	Please power off and on the machine.
7	Noise during cleaning	The main brush, side brush or main wheel may be stuck with foreign matters. Please clean them off after powering off.
8	Cleaning capacity decreased or dust dropped out	The dust bin is full. Please empty it. The strainer is blocked. Please clean it. The main brush is stuck with foreign matters. Please clean them off.
9	Unable to connect to WIFI	WIFI signal is poor. Please make sure that the machine is in an area with good WIFI signal reception. Abnormal WIFI connection: Please reset WIFI and download the latest mobile app to retry connecting.
10	Timer cleaning not working	The battery level is low. Time cleaning can start only if the battery level is above 20%.
11	Is the battery being drained if the machine sits on the dock charger?	The battery usage is extremely low when the machine sits on the dock charger to maintain an optimal battery performance.

Troubleshooting

No.	Problem Type	Solution
12	Do I need to charge the battery for at least 16 hours for the first three uses?	The lithium battery has no memory effect, so it's okay to just fully charge it.
13	No or little water during mopping	Please check whether there is water in the water tank, rinse the mopping cloth, replace the filter or follow the instructions in the user manual to correctly install the mopping cloth.
14	Too much water during mopping	Please make sure that the water tank cover and the filter are properly installed in place.
15	Cleaning does not resume after recharging	Please make sure that the machine is not in Do Not Disturb mode, in which cleaning cannot resume. Cleaning resumption is not available in the case of manual recharge or putting the machine onto the dock charger.
16	Unable to return to the dock charger after spot cleaning or position change	The machine will re-generate a map after spot cleaning or a significant position change, and if the dock charger is far away, the machine may not be able to automatically return for recharge. Please put it onto the dock charger manually.

Regular Maintenance

Recommended Robot Care

To keep Roborock running at peak performance, perform the care procedures according to the following frequency. If you notice Roborock picking up less debris from your floor, then empty the dust bin, clean the filter and clean main brushes

Robot Part	Care Frequency	Replacement Frequency
Dust Bin	Once per week	-
Mop	After each use	Every 3-6 months
Washable filter	Once per two weeks	Every 3-6 months
Water Tank Filter Element components	-	Every 1-3 months
Side Brush	Once per month	Every 3-6 months
Main Brush	Once per week (twice per week in homes with pets)	Every 6-12 months
Omni-directional wheel	Once per month	-

Note: Roborock manufactures various accessory parts and assemblies. More details of accessory parts by visiting www.roborock.com or contact Roborock Customer Care for more information.

Holiday Energy Saving Function

When the cleaner is on the charging dock, hold and press "Recharge" for 10 seconds until you hear a "Ding-dong" sound, and Holiday mode will be activated.

In this mode, the LED indicator will dim, functions that has nothing to do with charging such as cleaning, recharging and remote control via WIFI will be disabled, and the cleaner will enter low power consumption mode to maintain optimal battery performance.

After Holiday mode is activated, you can disable it by holding and pressing "Recharge" for 10 seconds until the LED indicator brightens.



Robotic Vacuum Cleaner

Manufacturer: Beijing Roborock Technology Co., Ltd.

Product Model: E2*****, E3***** (*can be 0 to 9, A to Z, a to z, "-", "_", "\", "/" or blank, for marketing purpose.)

Address of Manufacturer: Floor 6, Suite 6016, 6017, 6018, Building C, Kangjian Baosheng Plaza,
No. 8 Heiquan Road, Haidian District, Beijing, P.R. CHINA

For more product information, please visit our website: www.roborock.com

For after-sales support, please email our after-sales service team:

US/Non-Europe Support: support@roborock.com

Europe Support: support@roborock-eu.com