

190mm

130mm

# UV Vacuum Cleaner User Manual

— KC101



**司 西 圭 地 氏**  
爱上洁净的家

Please read this instruction manual carefully before using the product and keep it properly.

Important safety instruction	1
Product Description	3
Operating Instruction	5
Cleaning & Maintenance	7
Trouble Shooting	9
Technical Parameters	10
Company Information	12

—

# Important safety instruction

## About this user manual

- **Please read all the contents of this manual carefully before using this product.**
- **Keep this manual in a safe place. If you transfer the product to a third party, please attach this manual together with the machine.**
- **Any operation that does not comply with the instructions of the manual may result in serious personal injury, property damage or damage to the product itself.**
- **Our company does not bear the relevant legal liabilities for losses caused by failure to follow the instructions in this product description.**

## **Attention**

This product is not waterproof, please do not inhale water and damp dust.

This product is a household bed smashing device. Do not use it to absorb construction waste or heavy metal dust.

## Personnel Safety

- **For instructions on your personal safety, please read these carefully to avoid accidents and possible damage to the product.**
- **This product is not intended for use by people who have no experience and knowledge of bed mites, including children at home, unless they are supervised and responsible for their safety**
- **When working on the product, please be careful to avoid danger.**
- **Do not stand or sit on this product.**
- **Keep this product in a safe place, and keep it out of reach of children and those who are unable to judge the environmental risks.**
- **Do not store this product in a high place to avoid the risk of accidental fall.**

## Product safety instructions

- This product is not intended for use by persons with physical, sensory or intellectual disabilities or those who lack experience and common sense (including children) unless they are supervised or directed to ensure that they are safe to use.
- This product is only suitable for working in a dry environment. Do not use it in a humid environment.
- Do not pump high temperature substances (cigarettes, matches or hot ash), ultra-fine materials (such as lime, cement, wood chips, gypsum powder, ash, toner, etc.), large pieces of sharp pieces (such as glass, nails, pins, etc.) , dangerous goods (such as solvents, detergents, etc.), chemicals (such as acidic substances, detergents, etc.), flammable and explosive liquids (gasoline, alcohol products).
- Keep the crystal flow passage and moving parts away from the hair, loose clothing, fingers and body parts. Do not point the air passage or tool at the eyes or ears.
- Please check the clear area before use. If you find tall paper, paper balls, plastic cloth or sharp objects, and things that are thicker than the straw diameter, please pre-exclude it to avoid the use of the pipeline is blocked and the use is severe
- If it is found, if it is found to be leaking or the motor temperature is too high and abnormal sound, such as hot body, abnormal sound, different sputum, weak service, etc., should stop immediately.
- Please check the dust cup regularly. If there is more garbage inside, please clean it up in time, keep the ventilation hole unobstructed to avoid the blockage and cause the force to drop. The motor will start the ship and reduce the service life of the hand-held wireless dust collector
- When cleaning the crystal, do not use lubricants, detergents, polishes, etc. to clean any parts.
- When the machine malfunctions, do not repair it yourself. Please call our after-sales department for assistance.

- This product is a power tool. Do not let the wireless vacuum cleaner run alone without being taken care of.
- Avoid getting the vacuum cleaner close to the heating appliance or violent to avoid a fire.
- Do not disassemble the dust cup, the UV lamp cover and open the air hood when the machine is powered or running to avoid injury or machine damage
- If the adapter is damaged, you need to purchase the original adapter

## Warning About UV Rays

- This product is equipped with ultraviolet sterilizing lamp, please avoid to watch the bottom of the machine when the power is on and the ultraviolet sterilizing function is on to prevent ultraviolet radiation from causing harm to human body
- Please don't expose animals and plants to ultraviolet rays to avoid damage
- Please do not concentrate uv rays in one place for continuous use, which may cause damage to cleaning objects
- When the ultraviolet sterilization lamp is opened, the eye cannot direct the ultraviolet ray lamplight, also cannot illuminate human body skin, lest cause damage to human body.
- Ultraviolet germicidal lamp is open, not with strong light, or direct sunlight photosensitive components at the bottom of the machine, lest cause performance obstacle, affect the normal use and life, cause accident harm to humans or animals
- If used for a long time, the position of the protective lampshade will accumulate dust, causing the UV lamp to keep on and lose the protection function to human body. In this case, dust the surface of the sensor probe with a clean cloth

# Product Description

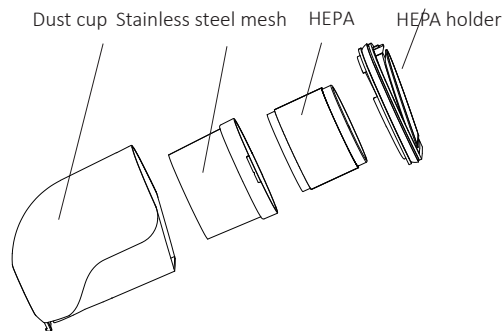
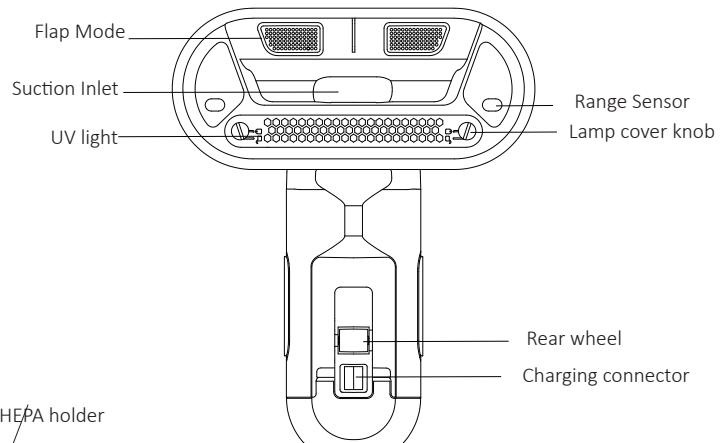
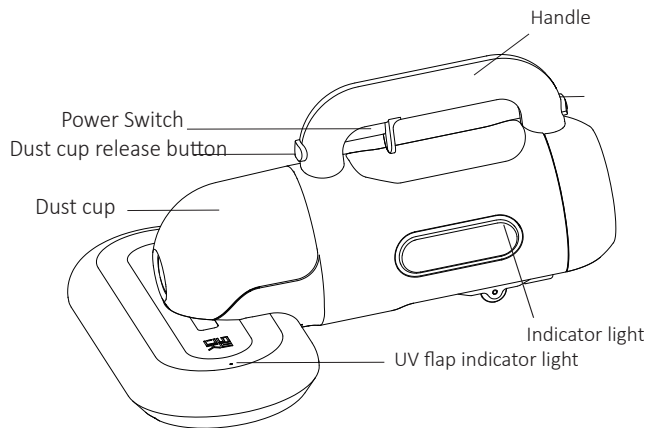

## Accessories List

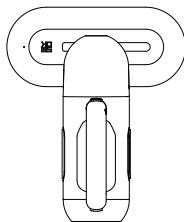

Machine



Charging Base

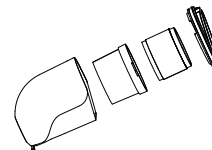

Dust cup accessories (has been assembled)



Adaptor

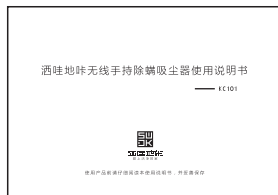

User manual

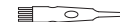

Brush

Attention 

Before assembling the product, please check the accessories list and confirm that all parts have been received

## Operating instruction

### Preparation before using

- Make sure the components of the UV vacuum cleaner are assembled in place.
- Check whether the power is sufficient to ensure the product works normally

## Charging Instructions

- Plug the adapter into the charging base and the other end into the power socket
- Do not turn on when charging
- The power indicator light is fully charged when it is on in all three cases .

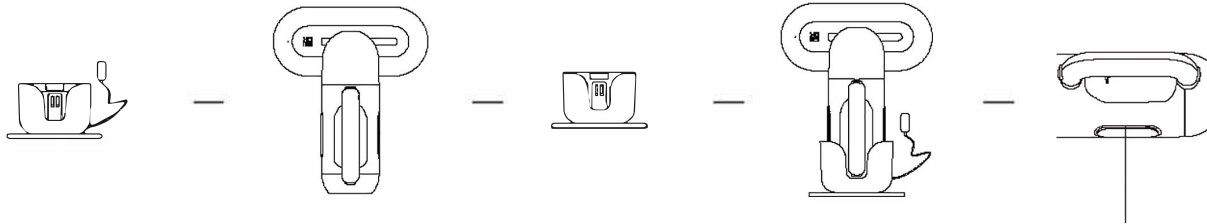

The power indicator flashes in turn when charging

## Attention

- Put the machine into the charging base, and the power indicator will flash in turn to start charging
- Please charge the battery fully when you use a new battery or first use it after long-term storage
- Please charge more than 3 hours before the first use

## How to use

### Indicator light

Switch button shortly, the light is on after starting up, the machine is started, all functions are started with one key, and the short button is pressed to turn off (all functions are stopped)

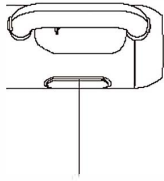

- 3 lights 100%
- 2 lights 65%
- 1 light 30%
- 1 light to flash, need to be charged

### Attention

To avoid accidental pet injury, UV lamp equipped with infrared sensor probe safety switch, off the surface of the object automatically UV off.

## UV and Flap Instructions

- When the machine touches the object surface, the infrared sensor detects the object. When the UV light is on, the flap mode starts. Away from the surface of the concealment object, the infrared induction probe cannot sense the object, the UV light and the flap mode is closed, the UV and the flap indicator work synchronously

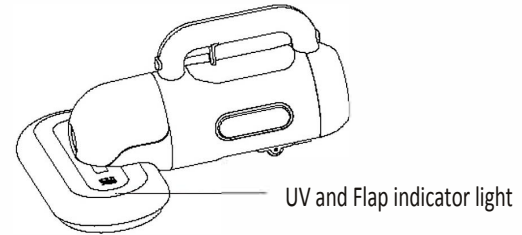



# Cleaning & Maintenance

## Clean Dust Cup

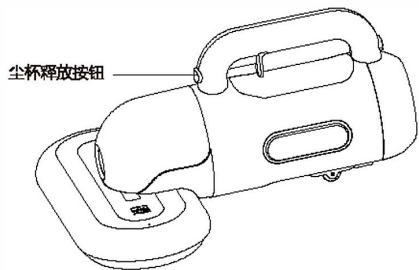

尘杯释放按钮

Press the release button to remove the cup

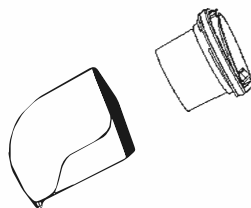

Remove the dust cup

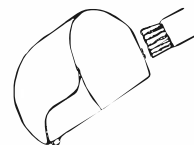

Clean the dust cup with the brush

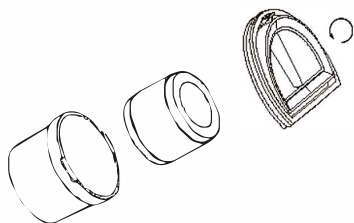

Open the mesh in the main clockwise direction



Clean the metal filter cover, washable

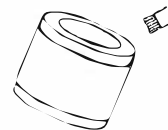

Clean HEPA with brush

## Exhaust Sponge

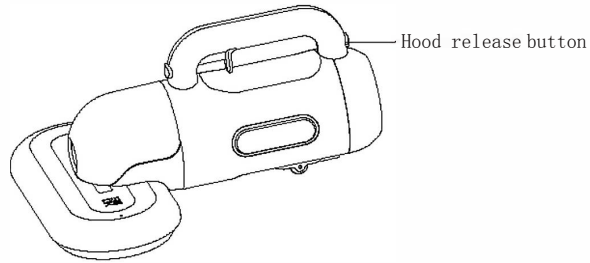

Press the release button to open the hood

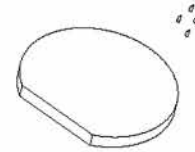

Remove the air filter sponge , washable

## ATTENTION ⚠

All washable parts can be put into the main machine after they are dried.

### Daily storage

- When not using the machine for a long time, please put the machine in a cool and dry place, do not put the machine in direct sunlight or moist environment
- When you do not use the machine for a long time, please make sure to charge and discharge at least once every three months

## Trouble shooting

When there is malfunction of the machine, please refer to the following chart for trouble shooting.

Details	Possible Reasons	Treatment
Machine not work	1 Low battery	please charge battery in time
	2 Do not press the power switch	Press the switch
Less suction	1 Metal mesh or the HEPA filter is blocked	Clean the dust cup, mesh or HEPA filter
	2 The suction of the machine is blocked	Clean the suction
UV light not work	<b>1 Object surface is not smooth or the machine bottom does not fully touch the object, resulting in the induction probe in a protective state</b>	Keep the surface flat or the machine bottom the in full contact with the cleaned object
	2 lamp tube damaged	Change the lamp tube
Too much noise	1 Full dust cup	Stop using and clean up the blockage
	2 The machine suction is blocked	
	3 The dust cup filter or HEPA filter is blocked	
	4 No filtering component is installed	Install the filter component

## Technical Parameters

Product Type	UV Vacuum Cleaner
Product model	KC101
Voltage	21.6V
Power	100w
Max Power	120w
Capacity	≥0.4L
UV lamp power	6w
N.W.	1.3kg
Charging time	2.5h
Adapter voltage Input	100-240V~ 50/60Hz 1A
Adapter voltage Output	DC 26V 1A
Working time	≥25min
Battery capacity	2200mAh

## Hazardous Substances Contained in Components

Components	Hazardous Substances					
	Lead (Pb)	Mercury (Hg)	Cadmium (Cd)	Chromium (Cr (VI))	Polybrominated bipheny (PBB)	Polybrominated diphenyl ethers (PBDE)
Plastic	O	O	O	O	O	O
Motor	X	O	O	O	O	O
Circuit boards and components	O	O	O	O	O	O
Adapter	O	O	O	O	O	O
Metal Parts	O	O	O	O	O	O
Battery	O	O	O	O	O	O
Others	O	O	O	O	O	O

The chart is based on the regulation of SJ/T11364

**O:** Means the content of the hazardous substance indicated in contained in the component is within the limits set by GB/T26572.

**X:** Means the content of the hazardous substance indicated in contained in the component is higher than the limits set by GB/T26572.

(All components labeled with X met the requirement of European Union RoHS, Or no substitutes can be found due to current technology level)

(This chart covers all the products of SWDK. However, not every products contain all 11

components described in the charts)

